

www.sbmchina.com



VSI 系列高效冲击式破碎机
VSI Series Crusher

上海世邦机械有限公司
SHANGHAI SHIBANG MACHINERY CO.,LTD.

中国上海浦东金桥南区建业路416号
No.416 Jianye Road, South Jinqiao Area, Pudong
New District, Shanghai, China

邮编 (Postcode): 201201

国际市场部 : International Trade Department

Tel: 0086-021-58386176
0086-021-58386189

Fax: 0086-021-58386211

Email: sbm@sbmchina.com

国内市场部 :

Tel: 400-696-1899 (24小时销售热线)

021-58386699

Fax: 021-58385681

品质与文明之光闪耀世界
The light of quality and civilization
shines the world

www.sbmchina.com

VSI系列高效冲击式破碎机

品质与文明之光闪耀世界！

THE LIGHT OF QUALITY AND CIVILIZATION SHINES THE WORLD!

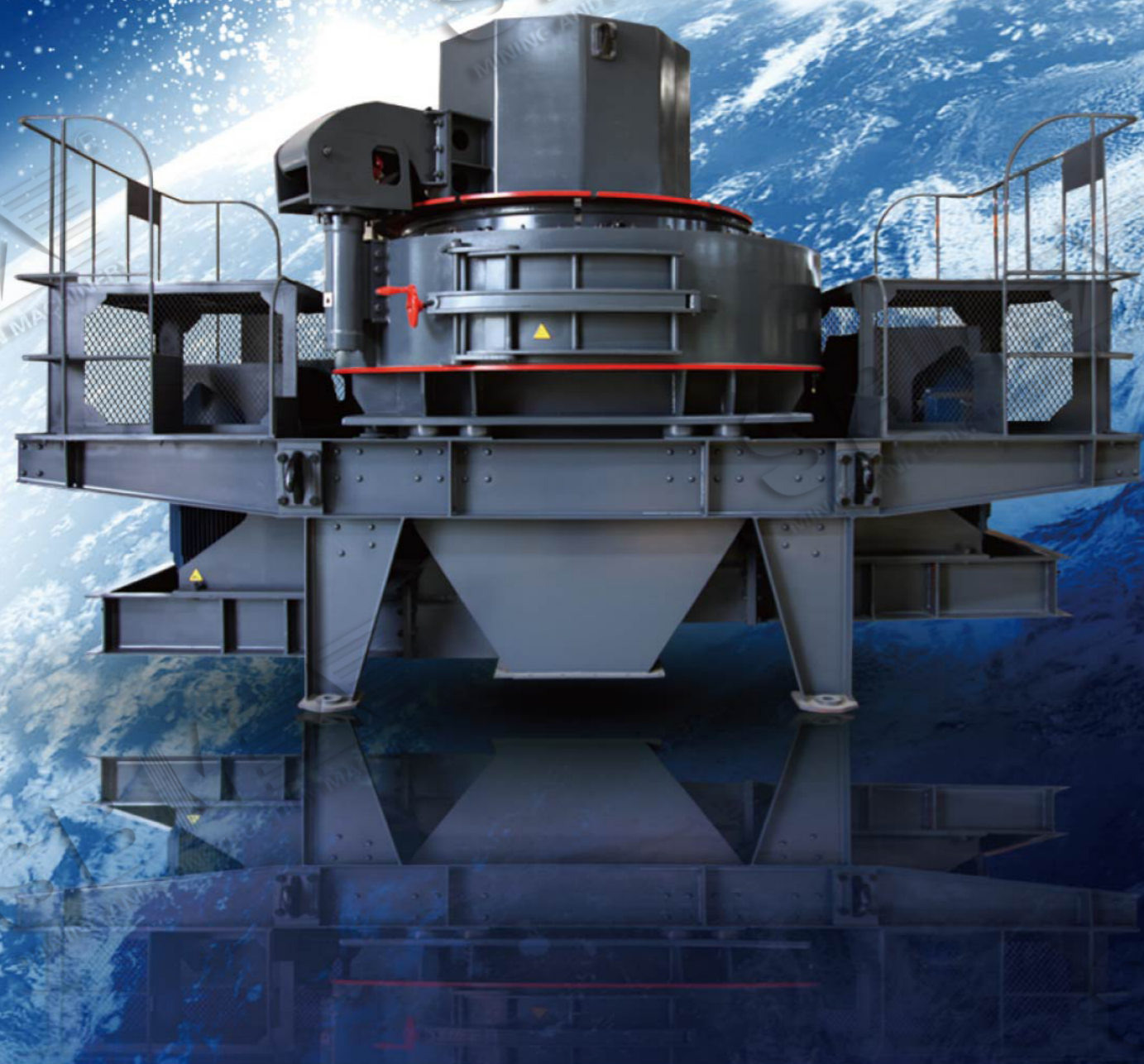

VSI系列高效冲击式破碎机 PRODUCT OVERVIEW 产品概述

随着中国经济的快速发展，“十二五”计划的全面展开，水利设施、公路、桥梁的建设急剧增加，建筑用砂也随之增加，供求矛盾已达白热化。国家对已近枯竭的天然砂保护日益严格，对建筑质量的要求也越来越高。机制砂迅速取代天然砂成为建筑用砂主流，机制砂的时代已然来临。

Along with instant development of Chinese economy and overall spread of "the 12th five-year plan", constructions of water conservancy facilities, highway and bridge rapidly increase, along with which building sand increases; the supply and demand contradiction has turned white-hot. National protection for already exhausted natural sand is increasingly strict. The requirement for construction quality is also higher and higher. The machine-made sand rapidly supersedes natural sand to become building sand mainstream. The era of machine-made sand has come.

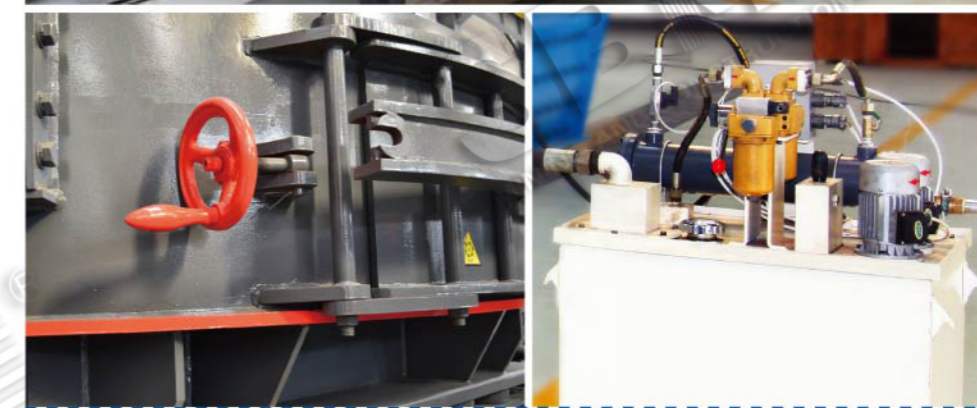

VSI 系列高效冲击式破碎机 CHARACTERISTIC FEATURE 性能特点

VSI系列冲击破碎机是在我公司多年研制、开发、生产矿山机械的基础上，吸取国内外同类产品的先进技术开发的具有国际先进水平的新一代节能、高效破碎机，其性能在各种矿石细碎设备中起着不可替代的作用。该设备可广泛应用于金属和非金属矿石、建筑材料、人工造砂以及各种冶金矿渣的破碎与整形。本机适用于莫氏硬度小于9级的脆性物料，不适用于粘性物料以及含泥土较多的石料。

VSI series impact crusher is a new generation energy-saving, high efficiency crusher with international advanced level, developed by our company on the basis of researching, developing and producing the mining machinery for many years and absorbing advanced technology of like products at home and abroad. Its performance plays an irreplaceable role in all kinds of ore fine grinding equipments. This equipment can be extensively used for crushing and reshaping of metal and non-metallic ores, building material, man-made sand and all kinds of metallurgical slag. This machine is applicable for brittle materials with Mohs hardness less than Class 9, not applicable for viscous material and stone containing much clay.



VSI 系列具有广泛的应用场合

VSI series is extensively used in occasions below

1. 河卵石、山石、矿石尾矿、石屑的人工制砂。
2. 建筑骨料、路面料、垫层料、沥青混凝土和水泥混凝土骨料的生产。
3. 工程领域的水利水电、高等级公路、高速公路、高速铁路、桥梁、市政工程的机制砂生产和石料整形。
4. 矿业领域的磨矿前段细碎工艺，建材、冶金、化工、矿山、耐火材料、水泥、磨料等行业的物料破碎。
5. 高磨蚀性和二次解体破碎，火电、冶金行业的除硫，钢渣、建筑垃圾破碎等环保项目。
6. 玻璃、石英砂和其他高纯度材料的生产。

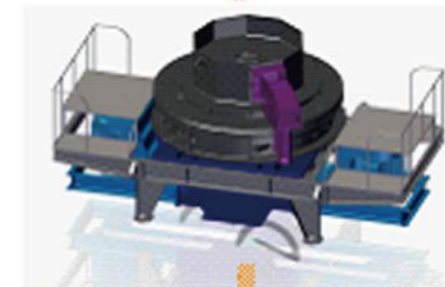
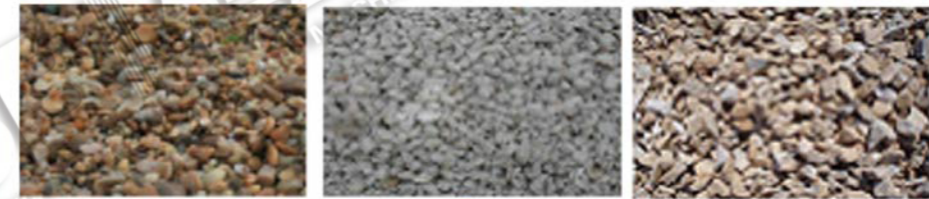

1. Sand fabrication from river gravel, mountain stone, ore tailings, stone chips.
2. Production of building aggregate, road surface material, and cushion layer material, bituminous concrete and cement concrete aggregate.
3. Machine-made sand production and stone reshaping in water conservancy, hydroelectricity, high class highway, expressway, high-speed railway, bridge and municipal engineering fields.
4. Fine crushing process at early stage of ore grinding in mining field, material crushing in building material, metallurgy, chemical engineering, mine, refractory material, cement, grinding material and other industries.
5. High abrasability and secondary disorganization crushing, desulphurization, steel slag, builders rubbish crushing and other environment protection projects in thermal power and metallurgy industries.
6. Production of glass, quartz sand and other high-purity materials .

T VSI 系列高效冲击式破碎机 TECHNICAL ADVANTAGE 技术优势

先进可靠的双泵供油润滑系统—性能稳定、寿命长

Advanced, reliable dual pump oil supply lubrication system—stable performance, long life

德国原装的稀油润滑站，双油泵互补保证供油，无油流、无油压时自动停机；油液冷却及加热装置确保轴承润滑始终处于最佳状态。从而彻底解决轴承发热等问题，使主轴轴承保持恒温，延长维护周期和使用寿命。

Dual oil pump complementation of thin oil lubrication station originally imported from Germany ensures oil supply and automatic shutdown without oil flow and oil pressure. The oil liquid cooling and heating equipment ensures that bearing lubrication is always in the groove, thereby thoroughly solving bearing heating and other problems, ensuring main shaft bearing keeps constant temperature and prolonging maintenance interval and service life.

液压起顶装置—维修方便、省时省力

Hydraulic pressure jack device—convenient, timesaving and laborsaving for maintenance

液压开盖装置，在需要检修时通过液压千斤顶工作，快速开盖。使破碎腔内部件检修拆换方便快捷，缩短了停机时间，省时省力，大大地节约成本。

When it needs repairing, the hydraulic pressure uncapping device can quickly uncap through hydraulic jack to ensure that components in chamber are repaired and replaced conveniently and quickly, which is timesaving and laborsaving, shortens downtime and greatly economizes cost.

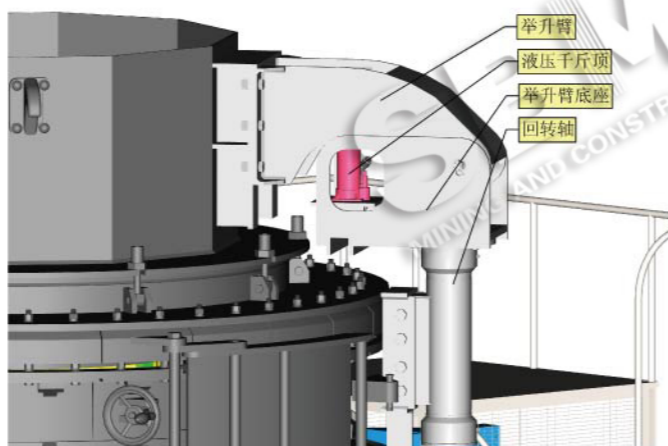

- 举升臂 Lifting arm
- 液压千斤顶 Hydraulic jack
- 举升臂底座 Lifting arm pedestal
- 回转轴 Rotating shaft

安装方式选择—安装简便、方式多样、易于操作

Installation mode selection—handy installation, diversified modes, easy to operate

设备重量轻、安装方式多样，可固定安装；也可配于移动破碎站上。且主机配套设施齐全，其安装、维修和保养简单。

The equipment is light in weight and diversified in installation modes, can not only be installed fixedly, but also matched with mobile crushing station. Moreover, supporting facilities for main unit are complete with simple installation and maintenance.

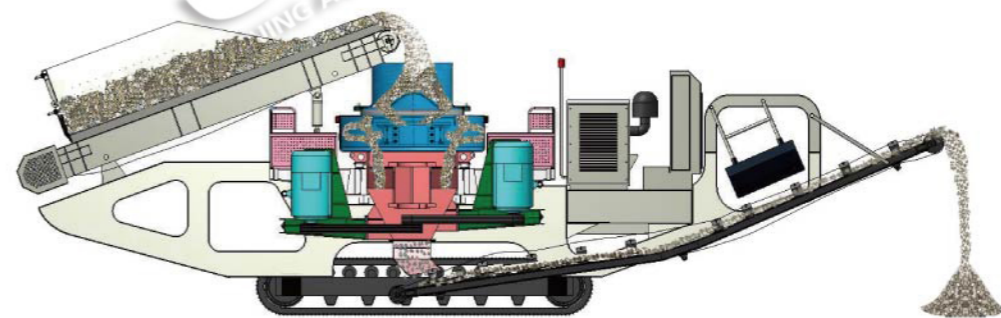

“石打石”、“石打铁”方便转换—一机多用、应用灵活

Convenient switchover between "PL" and "PLST"—a machine serves several purposes with flexible application

采用本公司独有的进料破碎结构，拥有多种破碎腔型，可很方便的实现“石打石”和“石打铁”的转换，从而解决了一机多用的难题。如果要改变VSI破碎机的应用，无需做大的调整，既可适应用户的不同需求：人工制砂、碎石整形、磨蚀物料等。

With particular feedstock crushing structure of this company and manifold crushing chamber types, it can very conveniently realize switchover between "PL" and "PLST", thereby solving the multipurpose puzzle. If VSI crusher application needs to be changed, only a little adjustment can adapt to different demands of users: sand fabrication, macadam reshaping, abrading material, etc.

破碎原理的选择—冲击破碎，粒形优良

Crushing principle selection—impact grinding with superior particle shape

产出的产品呈立方体，粒形好、级配合理、细度可调；特别适合人工制砂和石料整形，实践证明比其他传统设备制砂、整形效果提高30%。

The product is cubic with good particle shape, reasonable gradation and adjustable fineness degree, especially suitable for sand fabrication and stone reshaping. It is proven in practice that its sand making and reshaping effects are 30% higher than those of other traditional equipments.



- ① 整形后物料放大图
Enlarged view of post-reshaping materials
- ② 整形前，物料
Materials before reshaping
- ③ 反击破物料
Materials by impact crusher
- ④ 圆锥破物料
Materials by cone crusher

腔型优化设计——易损件消耗低、降低使用成本

Chamber type optimization design—low consumption of wearing parts, reducing use—cost

最佳的破碎腔物料撞击角度设计，与耐磨件的摩擦少，比传统设备运行费用低30%，直接降低了设备的使用成本。

Optimal material impact angle design in crushing chamber ensures little friction with wear-resistant parts and is 30% lower than running cost of traditional equipment, directly reducing equipment use-cost.

VSI 系列高效冲击式破碎机 STRUCTURAL COMPOSITION 结构组成

VSI制砂机主要由顶盖回转总成、转子总成、轴承室总成、支架总成和上下机架总成等几大部分构成。
VSI sand making machine mainly consists of coping gyration assembly, rotor assembly, bearing chamber assembly, bracket assembly, upper and lower chassis assembly, etc.

- 1. Coping gyration assembly
- 2. Upper chassis assembly
- 3. rotor assembly
- 4. Bearing chamber assembly
- 5. Motor driving part
- 6. Bracket assembly
- 7. lower chassis assembly

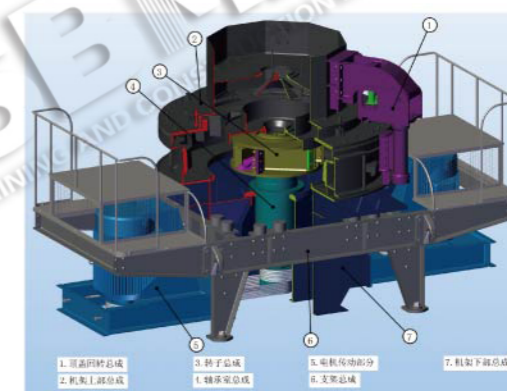

VSI 系列高效冲击式破碎机 OPERATING PRINCIPLE 工作原理

VSI系列高效冲击式破碎机的工作形式可分为四种：中心进料伴随瀑落进料“石打石”和“石打铁”，完全中心进料“石打石”和“石打铁”。

VSI5X series high efficiency impact crusher can be divided into 4 operating modes: center feedstock accompanied by cascade feedstock "PL" and "PLST", entire center feedstock "PL" and "PLST".



图1 中心进料伴随瀑落料石打石(左) / 石打铁(右)
Fig. 1 center feedstock accompanied by cascade material PL (left) / PLST (right)



图2 完全中心进料石打石(左) / 石打铁(右)
Fig. 2 Entire center feedstock PL (left) / PLST (right)

生产线配置及现场

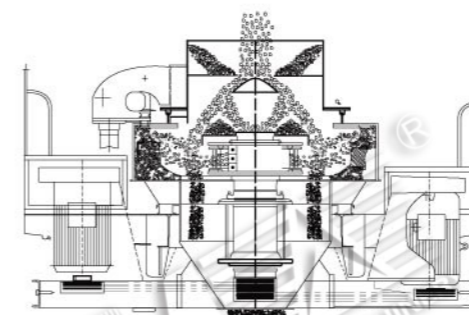
Production line configuration and site

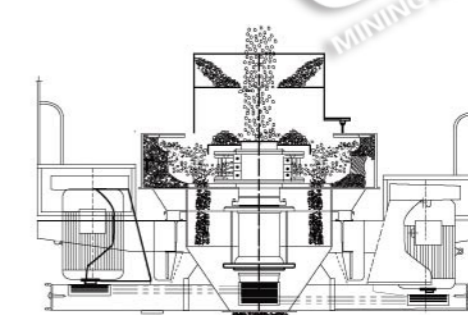
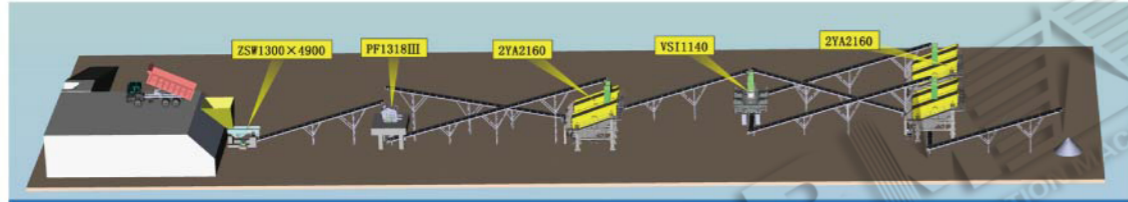

主要技术参数 Main Technical Parameters

型号 Model		VS17611	VS18518	VS19526	VS11140
生产能力 Productive capacity (t/h)	瀑落与中心进料 Cascade and center feedstock	120~180	200~260	300~380	450~~520
	全中心进料 Entire center feedstock	60~90	100~130	150~190	225~260
最大入料尺寸 Maximal feed	软料 Soft material	< 35	< 40	< 45	< 50
	硬料 Hard material	< 30	< 35	< 40	< 45
转速(r/min) Rotation speed (r / min)		1700-1890	1520-1690	1360-1510	1180-1310
双电动机功率(KW) Double motor power (KW)		110-150	180-220	264-320	400-440
最大外型尺寸 长×宽×高(mm) Maximal external dimension lwh (mm)		4100×2250×2285	4140×2280×2425	4560×2450×2780	5100×2690×3200
电源 Power supply		AC380GV,50Hz			
振动传感器 Vibrating sensor		监测范围:0.1-20mm/s Monitoring scope: 0.1 - 20mm / s			
润滑, 液压站 Lubricating hydraulic station	流量 (L/min) Flowrate (L / min)	6			
	双油泵电机功率(KW) Dual oil pump motor power (KW)	2×0.31			
	安全保护 Security protection	双油泵互补保证供油;无油流、无油压自动停机;水冷降温;冬季电机加热启动。 Dual oil pump complementation ensures oil supply, automatic shutdown without oil flow and oil pressure, water-cooling and motor heating start-up in winter.			
	外型尺寸长×宽×高(mm) External dimension lwh (mm)	820×520×1270			
	油箱加热器功率 Oil box heater power (KW)	2			